

RV-....-1 [®]

Operating Instructions

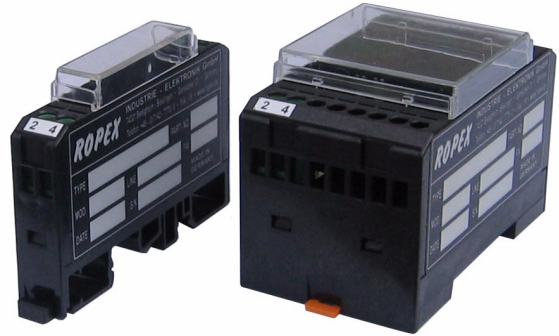

RESISTRON/CIRUS temperature controllers are designed to implement a large number of standard applications. The required secondary voltages and currents can be set within a wide range.

If - owing to the length of the heatsealing band - the required secondary voltage (U_2 or U_R) is higher than the maximum permissible voltage of the controller, an RV-....-1 series resistor must be used. This series resistor is inserted into the supply lead of the U_R measurement input.

The enclosure of the series resistor can be snapped onto a top hat rail (DIN TS35). The resistor must be installed directly adjacent to the RESISTRON/CIRUS temperature controller. Continuous twisting of the U_R measuring wire is essential - including between the series resistor and the controller.

⚠ The information provided in the ROPEX Application Report should be heeded when using the RV-....-1 in order to avoid malfunctions.

1 Technical data

Type of construction	Housing for installation in the electrical cabinet Snaps onto a standard top hat rail (DIN TS35 rail, 35mm) acc. to DIN EN 50022 RV-300V-1: Dimensions: 79 x 45mm; height: 53mm RV-..K.-1: Dimensions: 79 x 13mm; height: 53mm
Maximum permissible secondary voltage of the transformer	RV-300V-1: $U_{2max} = 300VAC$ RV-03K3-1: $U_{2max} = 40VAC$ RV-33K2-1: $U_{2max} = 240VAC$ RV-100K-1: $U_{2max} = 300VAC$
Standards	DIN EN 61010-1 (low voltage directive): Overvoltage category III, pollution severity 2, safety class II
Resistance	RV-300V-1: ---; electrical circuit RV-03K3-1: 3.3kohms; 0.6W RV-33K2-1: 33.2kohms; 0.6W RV-100K-1: 100kohms; 0.6W
Power loss:	RV-300V-1: max. 3.0W RV-03K3-1: max. 0.6W RV-33K2-1: max. 0.6W RV-100K-1: max. 0.6W
Ambient temperature	+5...+45°C
Degree of protection	IP20

Weight	RV-300V-1: approx. 150g RV-..K.-1: approx. 50g
Housing material	Plastic, UL-94-V0, self-extinguishing
Connecting cables Type / cross-sections	Rigid or flexible; 0.2...2.5 mm ² (AWG 24...12) Connection by means of screw terminals  If ferrules are used, they must be crimped in accordance with DIN 46228 and IEC/EN 60947-1. This is essential for proper electrical contact in the terminals.

2 RV-....-1/controller compatibility

In the course of various RESISTRON and CIRUS temperature controller upgrades, it has become necessary to make changes to the internal electronics to bring them into line with the currently available electronic components (the use of components containing lead is meanwhile banned by the European RoHS/WEEE Directives, for instance).

 **As a result, temperature controllers with DIP switches can only be operated with an RV-03K3-1, RV-33K2-1, or RV-100K-1 series resistor. Controllers without DIP switches (with a DIAG interface) are only allowed to be operated with a RV-300V-1 series resistor. Malfunctions or damage may otherwise occur.**

Please pay attention to the controller version when ordering spare parts. The controller may have to be exchanged together with the RV-....-1 series resistor. Refer to the compatibility tables below:

RV-300V-1 (controllers without DIP switches)

Controller type	Art. No.	Required series resistor
RES-401/...VAC as of October 2005	7401..	RV-300V-1 Art. No. 886200 (Refer to ROPEX Application Report)
RES-402/...VAC as of January 2006	7402..	
RES-403/...VAC as of October 2005	7403..	
RES-406/...VAC as of February 2006	7406..	
RES-407/...VAC as of April 2005	7407..	
RES-408/...VAC as of June 2006	74084.	
RES-415/...VAC as of February 2006	7415..	
RES-420/...VAC as of December 2005	7420..	
RES-440/...VAC as of March 2006	7440..	
RES-445/...VAC as of January 2006	7445..	

**RV-03K3-1, RV-33K2-1, RV-100K-1
(controllers with DIP switches)**

Controller type	Art. No.	Required series resistor
RES-401/...VAC up to September 2005	7401..	<p>RV-03K3-1 Art. No. 886203</p> <p>RV-33K2-1 Art. No. 886202</p> <p>RV-100K-1 Art. No. 886201</p> <p>(Refer to ROPEX Application Report)</p>
RES-402/...VAC up to December 2005	7402..	
RES-403/...VAC up to September 2005	7403..	
RES-406/...VAC up to January 2006	7406..	
RES-407/...VAC up to March 2005	7407..	
RES-408/...VAC up to May 2006	74080.; 74081. and 74083.	
RES-409/...VAC	7409..	
RES-415/...VAC up to January 2006	7415..	
RES-420/...VAC up to November 2005	7420..	
RES-440/...VAC up to February 2006	7440..	
RES-445/...VAC up to December 2005	7445..	
UPT-640/...VAC	66401. and 66402.	
LPT-640/...VAC	66405. and 66406.	

3 Installation procedure

3.1 Secondary circuit grounding

 If an RV-....-1 is used, the secondary circuit must always be grounded for safety reasons. If not, a short-circuit to frame on the heatsealing band could result in damage to the controller or injury to persons.

 If the secondary circuit is grounded at one end, terminal 1 on the RV-....-1 must be connected to the grounded end of the heatsealing band in order to avoid malfunctions and damage.

 Up to a secondary voltage of 240VAC, the circuit can also be grounded by tapping the neutral point of the transformer secondary winding (terminals 1 and 2 of the RV-....-1 can have any polarity).

3.2 Monitoring current transformer MSW-1

 If the secondary circuit is grounded, the use of an MSW-1 monitoring current transformer is recommended. This prevents overheating in case of a short-circuit to frame on the heatsealing band.

3.3 Controller alarm output/ contactor Kb

 If an RV-....-1 is used, a contactor for all-pole disconnection must be inserted between the controller and the impulse transformer (refer to the controller documentation, "Power supply", contactor Kb). This contactor must be energized directly via the controller alarm output to ensure that the heatsealing application is immediately disconnected in the event of an alarm.

4 Wiring diagram

4.1 RV-300V-1 (controllers without DIP switches)

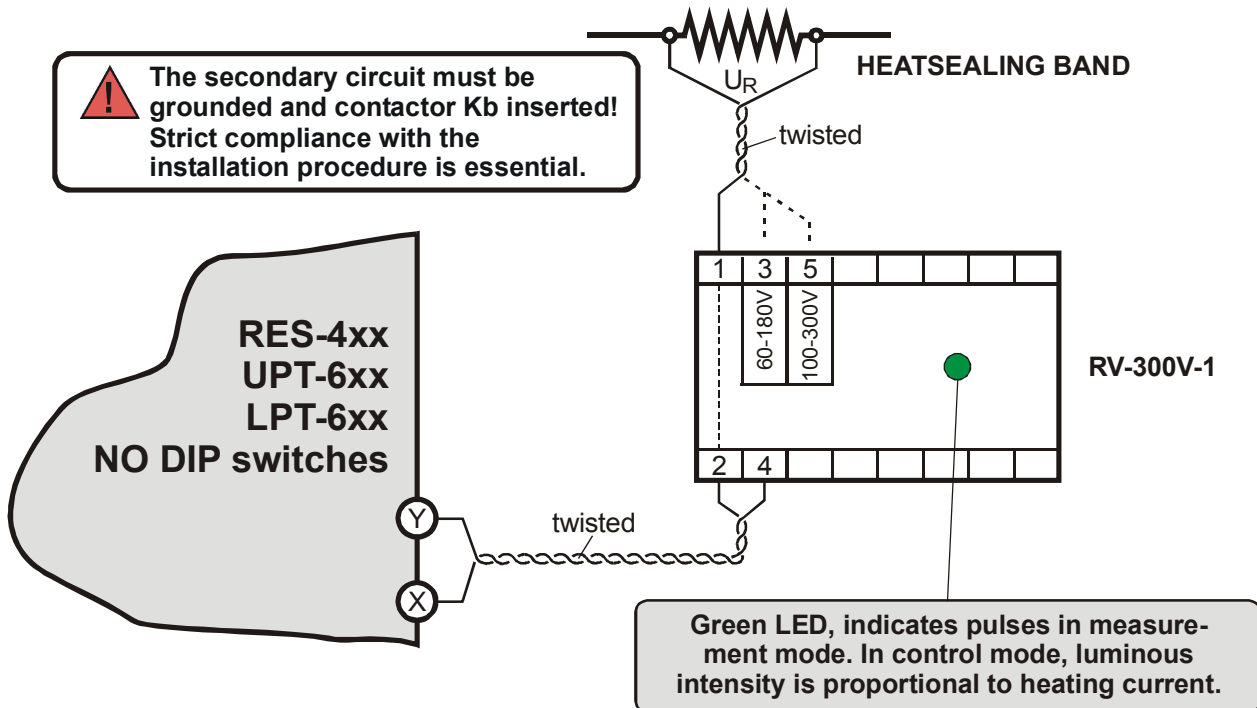

4.2 RV-03K3-1, RV-33K2-1, RV-100K-1 (controllers with DIP switches)

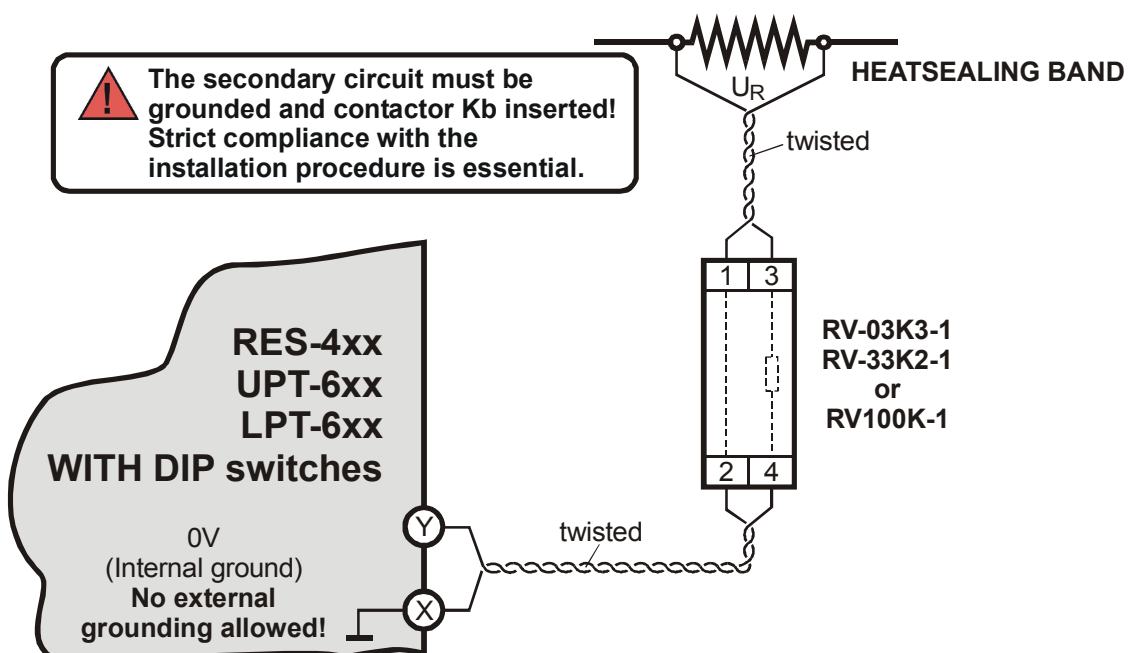

4.3 Connection between RV-....-1 and RESISTRON/CIRUS controller

Controller	RV-....-1	
	Terminal 2 connected to (X)	Terminal 4 connected to (Y)
RES-401 RES-403	Terminal 7	Terminal 9
RES-402	Terminal 8	Terminal 7
RES-406 RES-407 RES-408 RES-409	Terminal 9	Terminal 8
RES-415 RES-420 RES-440 RES-445 UPT-640 (CIRUS) LPT-640 (CIRUS)	Terminal 11	Terminal 10
RESCON-470 (as of 10/2000)	Terminal 20	Terminal 19

5 Dimensions

5.1 RV-300V-1

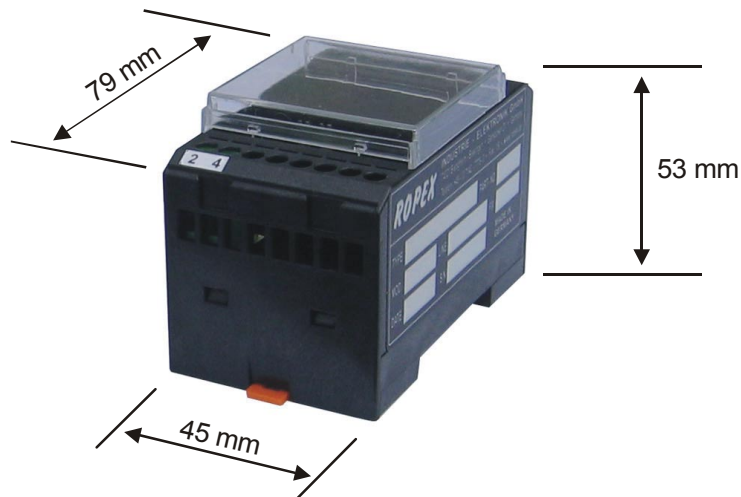

5.2 RV-03K3-1, RV-33K2-1, RV-100K-1

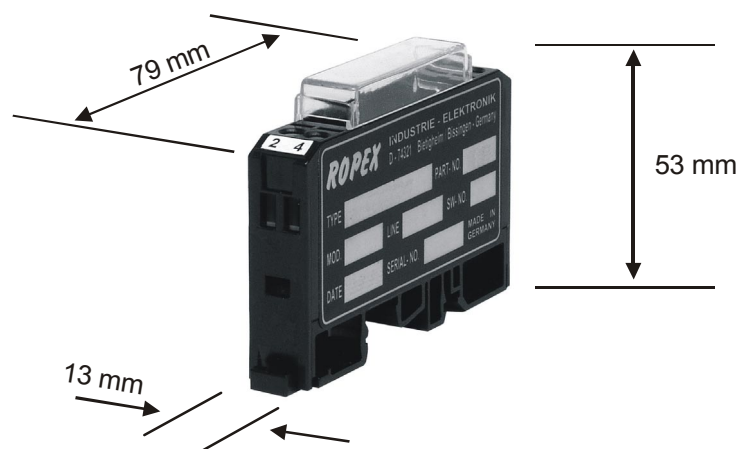

6 How to order

	RV-....-1 series resistor	
	RV-300V-1 (electrical circuit):	Art. No. 886200
	RV-03K3-1 (resistance 3.3kohms):	Art. No. 886203
	RV-33K2-1 (resistance 33.2kohms):	Art. No. 886202
	RV-100K-1 (resistance 100kohms):	Art. No. 886201